

page

Manually controlled air conditioner

- Control assembly	1
- Evaporator-heater assembly	2
- Three stage pressure switch	5
- Air conditioning and radiator/condenser cooling fan fuses and relays	5
- Air conditioning and radiator/condenser cooling system wiring and wiring parts	6
- Electrical problems	8
- Air conditioning wiring diagram	19

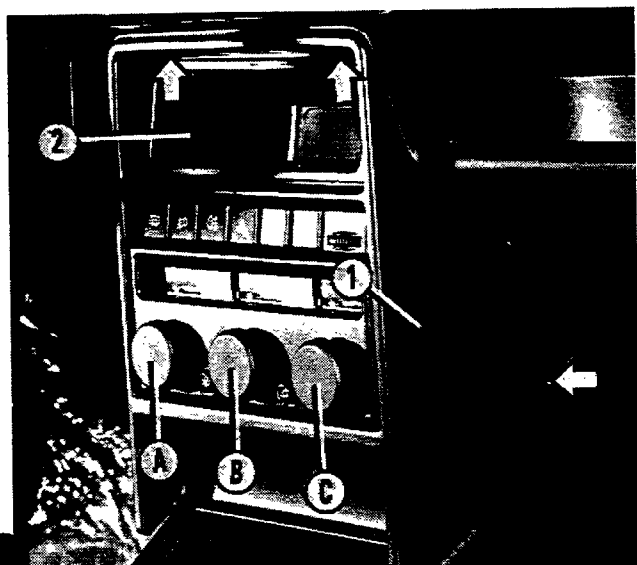

P30001H01



CONTROL ASSEMBLY

Removal

To remove control assembly, proceed as follows:

- turn knobs B and C fully anticlockwise, so that marker of knob B is at far end of blue zone (maximum cooling) and marker of knob C is in windscreen outlet position.
- unscrew bolts fastening top and sides of front cover (1) of instrument panel central console to facia;

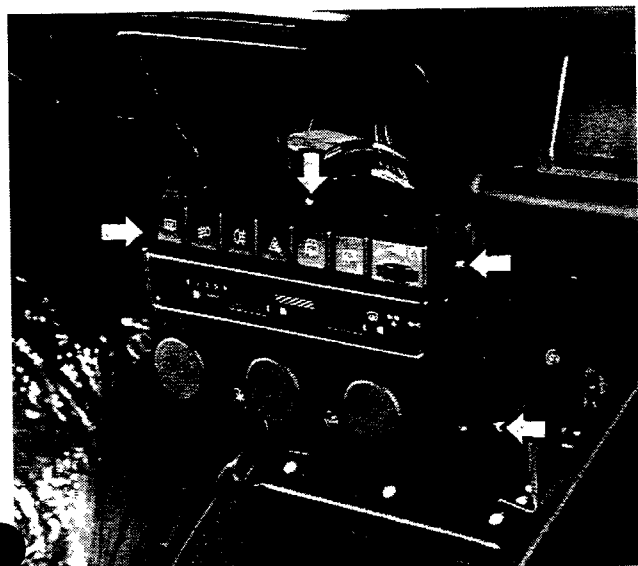

P30001H02



- remove front cover (1) together with radio compartment lining (2) from seat;
- unscrew bolts fastening air conditioning control panel and function control switch unit assembly to central console;

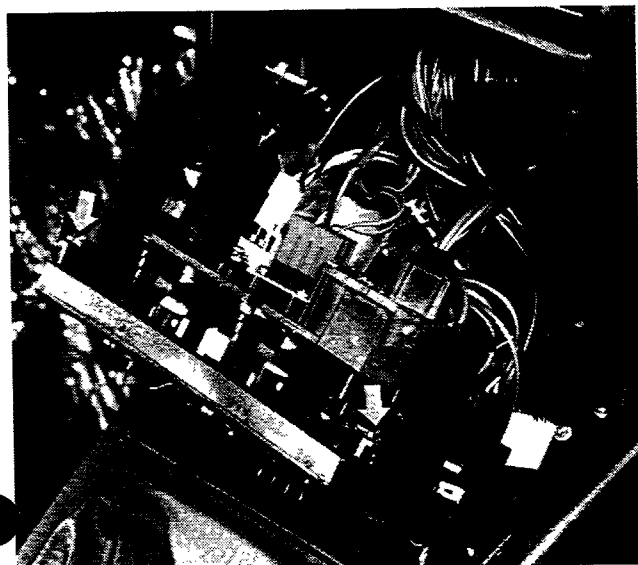

P30001H03



- remove the assembly from seat, bringing it forward as far as possible. Then disconnect rod ends (3 & 4, see overleaf), including joints, from shaft operating mixer/distribution flap mechanism;
- remove fixed press-fitted knobs (A, B, & C) from air conditioner control panel shafts;
- turn assembly through 180° and undo screws fastening air conditioner control panel mount to front facia (integral with functions control knob group);

50.

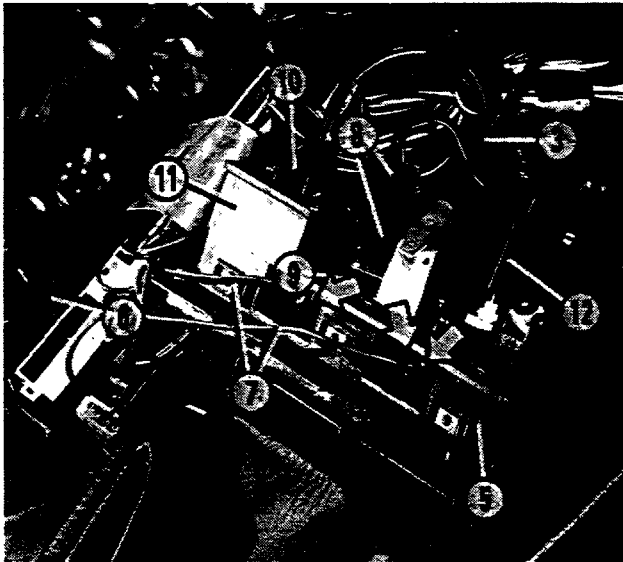

P30002H01



- remove air conditioner control knob mount (6) from front facia (5) and unfasten clips from top end to allow removal of pads to which the ends of the two fibre optic cables (7) are fitted;
- mark position of one of the two green connectors (8) and disconnect both from compressor activation control switch (9);
- disconnect connector (10) from terminals of passenger compartment ventilation fan switch (11);
- lastly, disconnect the two small pipes from vacuum switch (12) (after marking their position).

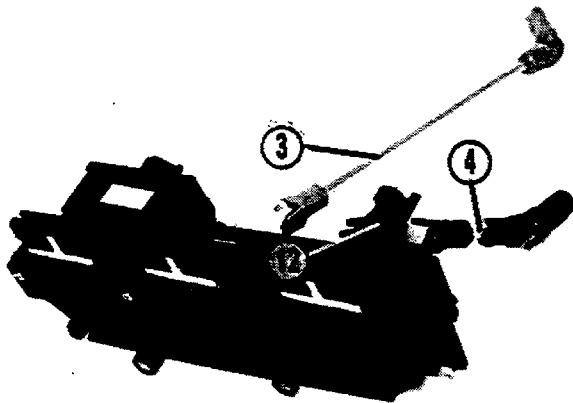

P30002H02



Detail of air conditioning control knob unit

- 3. Mixer flap control rod with swivel joint
- 4. Distribution flap control rod with swivel joint

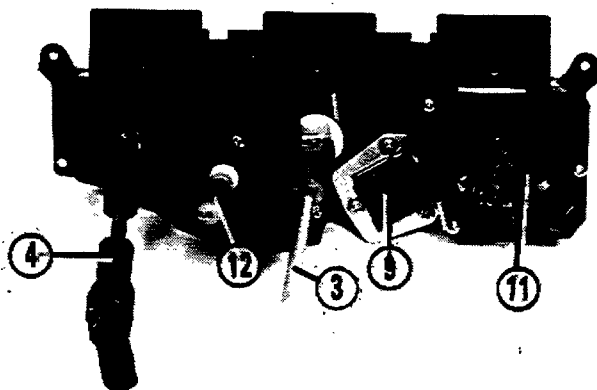

P30002H03



To disassemble air conditioning control unit, see explanation on pages 9 and 10 of publication for previous version (print no. 504.787/13, 91 range)

Detail of air conditioner control panel

- 9. Compressor activation switch
- 11. Passenger compartment fan speed selector
- 12. Air inlet flap pneumatic actuator vacuum control cylinder

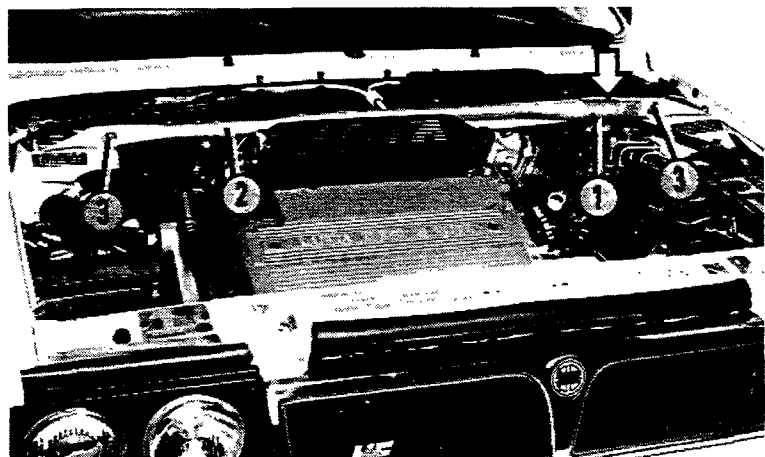

P30003H01



EVAPORATOR - HEATER ASSEMBLY

Removing

Carry out the following operations:

- disconnect terminal from battery negative;
- unscrew arrowed bolt and move sleeve (1) outwards;
- mark one side of bolt situated under the manifold. The purpose of the bolt is to keep crossbar (2) under tension;
- loosen the above bolt to release tension. Then undo bolts (3) fastening ends of crossbar (2) to brackets anchored to the upper attachment points of front suspensions;
- mark position of one of the two multiple connectors (4). Then disconnect both connectors from the electronic module (5), and unscrew the two nuts that fasten the module to the dashboard panel;
- disconnect connection (6) of thick orange cable supplying interior ventilation fan cable;

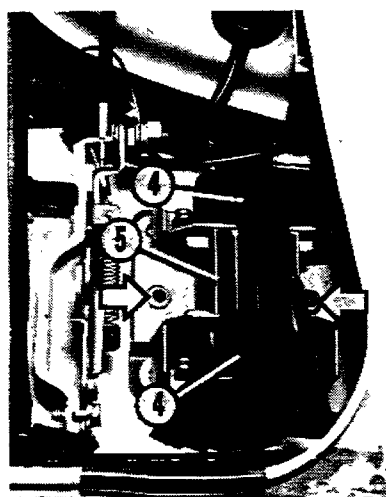

P30003H02

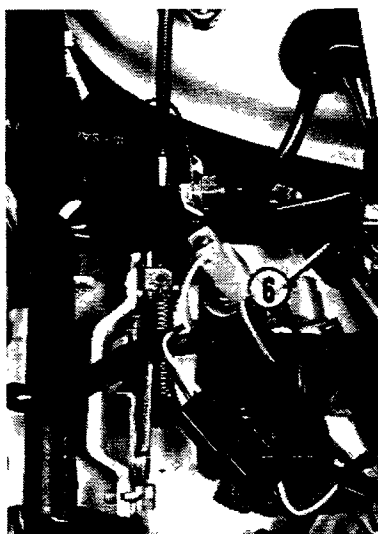

P30003H03



- disconnect the electrical connection of terminals to coolant level sensor (7), which is fitted inside the expansion tank (8). Then disconnect vent pipe (9) from expansion tank;

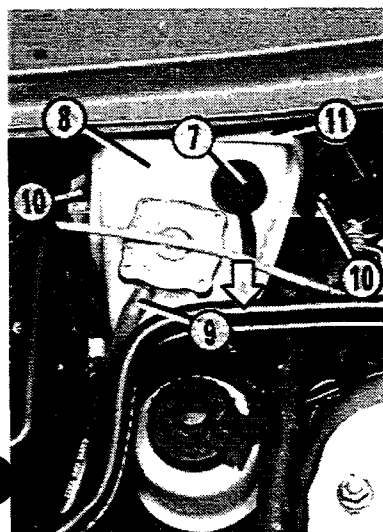

P30003H04

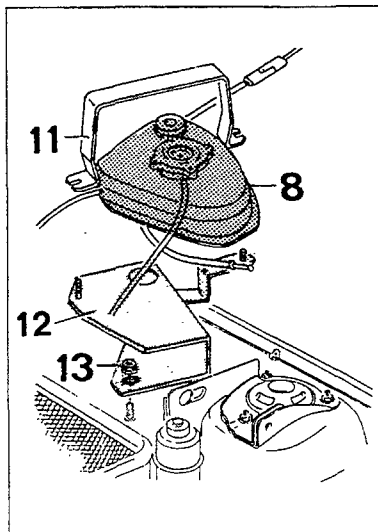

P30003H05



- unscrew nuts (10) fastening retaining bracket (11) of expansion tank (8) to underlying support bracket (12);
- disconnect pipes leading to engine and remove coolant expansion tank (8) from seat. Then unscrew nut (13) fastening lower end of support bracket (12) to body shell and remove bracket;

50.

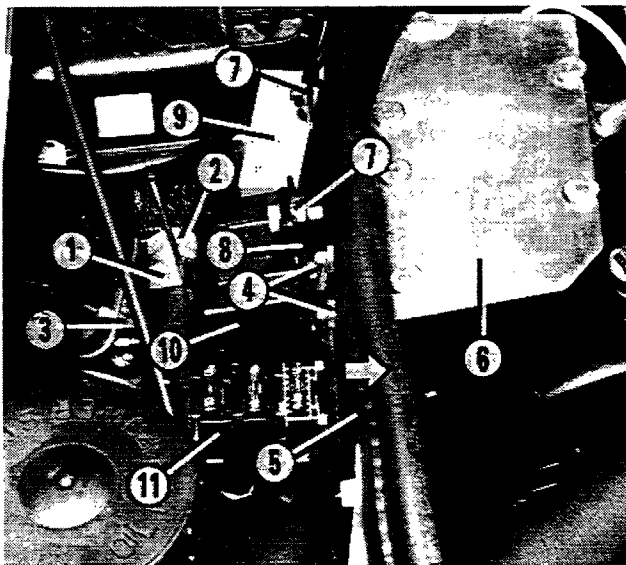

P30004H01



- **drain air conditioning system** (for procedure, see instructions on page 23 of manual for previous version, 91 range, print no. 504.787/13);
- unscrew fitting (1) and the one beneath it (not visible in figure) of pipes connected to evaporator outlet duct (2) and expansion valve (3);
- unscrew nuts (4) fastening pressure transducer support bracket (6) to paratia (5)
- unscrew nuts (7) fastening electronic module (9) and connector block (10) to bracket (8) on fascia (5);
- remove the three fuse carriers (11) from bracket (8);

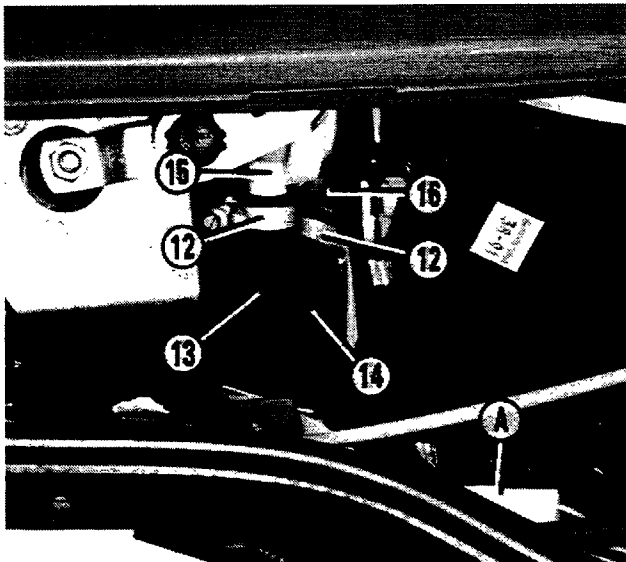

P30004H02



- drain engine cooling system;
- loosen clips (12) and disconnect both hoses (13 and 14) from heater radiator cock inlet/outlet ducts (15) & (16);
- unscrew the bolts fastening guard (17) to top surface of evaporator-heater unit, and loosen nut (18) joining evaporator-heater unit to anti-frost pressure switch (19);
- remove protection (17) and disconnect electrical lead heads (20) from anti-frost pressure switch tag terminals (19) ;

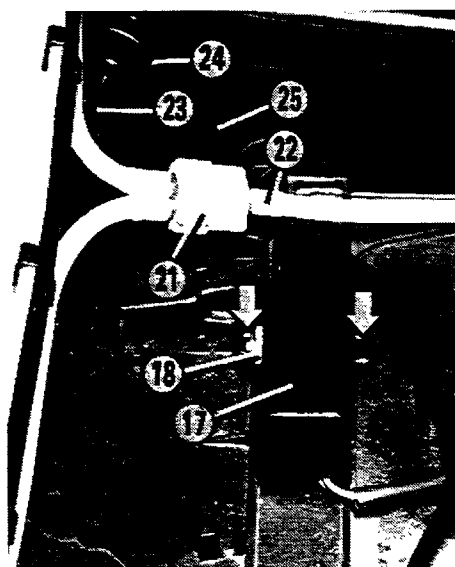

P30004H03

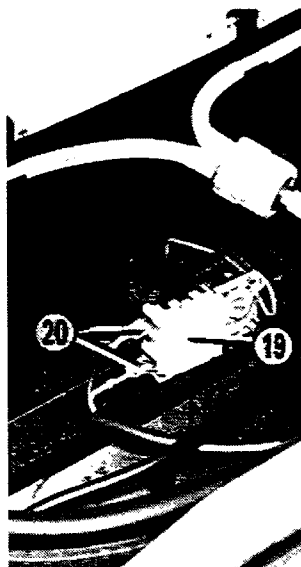

P30004H04



- draw out windscreen washer fluid (22) from three-way fitting (21);
- disconnect vacuum pipe (23) from air intake flap pneumatic actuator (24);
- disconnect pipe from one-way valve fitted to pipe (25) near actuator (24) and place pipe in front of front part of evaporator-heater assembly;
- remove pressure-fitted rubber sections from upper part of bulk-head (5) (indicated by arrows in top figure and in third figure on the left on previous page);

- disconnect connection of passenger compartment fan speed resistor cables (marked by letter A in centre figure on previous page);
- remove bulkhead from between engine bay and evaporator-heater assembly. Then remove control panel assembly followed by air distribution duct. Lastly, remove evaporator-heater assembly from housing beneath windscreen;

To remove, dismantle and reassemble the above components, including the above assembly, see manual for previous 91 range version (print no. 504.787/13)

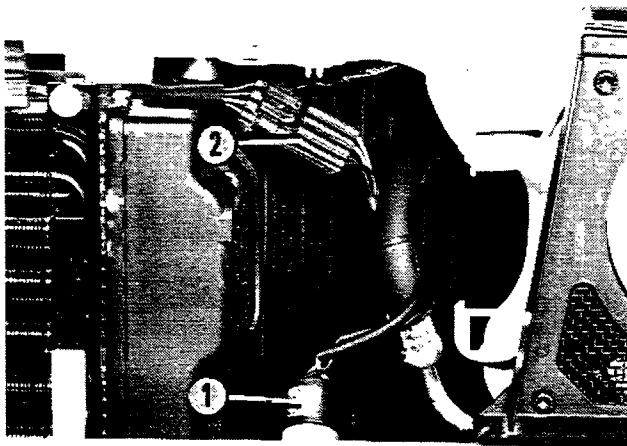

P30005H01

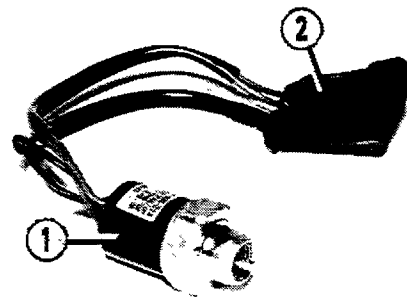

P30005H02

THREE STAGE PRESSURE SWITCH

The three stage pressure switch (1) differs from that fitted to the previous version in having cable terminals connect to a single connector.

To remove, proceed as follows: remove cover in front of condenser and front radiator, disconnect connector cable terminal connector (2) and then unscrew pressure switch from hose connecting condenser to dehydrating filter.

AIR CONDITIONING AND RADIATOR/CONDENSER COOLING FAN RELAYS AND FUSES

A black remote control switch (W), a delay device (Y) and a green relay (X) are fastened with bolts to plate (1). This is fitted to the front left hand engine bay lining, close to the headlamps, by means of nuts (2).

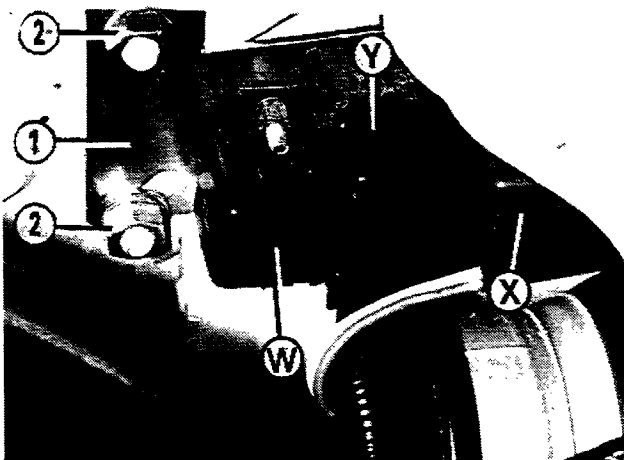

P30005H03

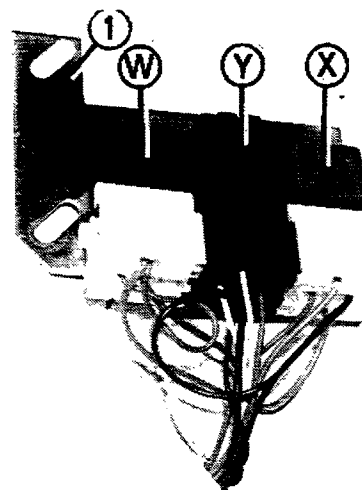

P30005H04

50.

A fuse holder (figure 3, centre page) with 10A fuse is joined with two other fuse holders fitted on the bracket fastened to the inner right hand side of the bulkhead separating the evaporator-heater assembly from the engine bay.

Two relays and a fuse holder with 25A fuse, together with other relays, are fitted to a bracket located under the right hand side of the instrument facia (first see bottom figure on page 13)

AIR CONDITIONING AND CONDENSER/RADIATOR WIRING SYSTEM AND PARTS

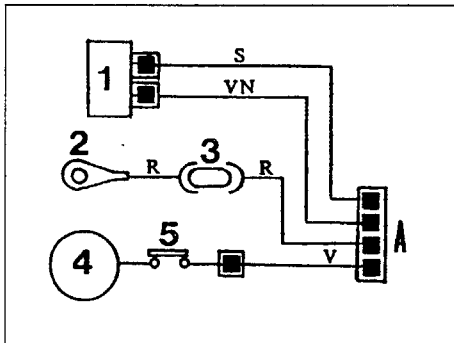

P30006H01

Main system wiring diagram

1. Anti-frost thermostat
2. Eye terminals fitted to connector block pillar
3. Fuse holder with 10 A fuse
4. Compressor
5. Thermal switch fitted to compressor
- A. Wiring connector

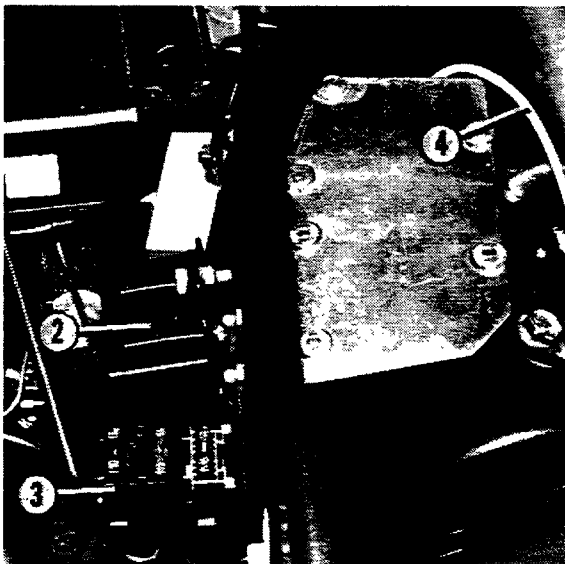

P30006H02

Location of parts wired to main system

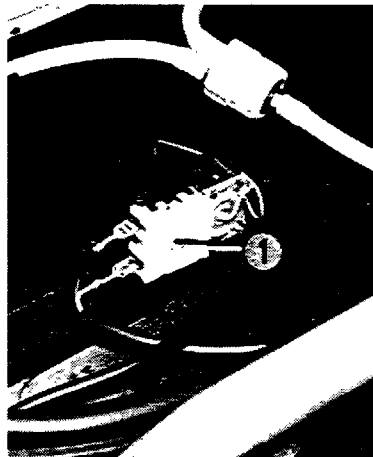

P30006H03

1. Anti-frost thermostat
2. Connector block
3. Fuse holder with 10 A fuse
4. White canvas-covered terminal lead of thermal switch fitted to compressor and connected to green lead leading to connector A.

Some of the air conditioning system wiring forms an integral part of the basic transverse wiring system. The leads are situated under the instrument facia and lead from the central console. They emerge from the dashboard into the rear left corner of the engine bay, below the windscreen

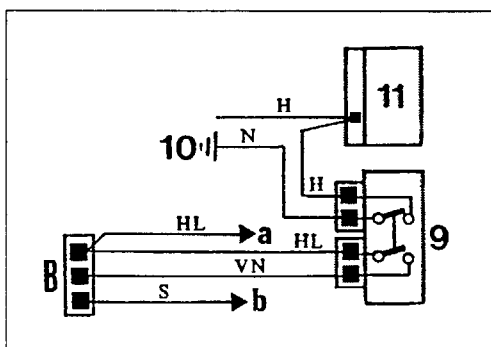

P30006H04

Wiring diagram of air conditioning system cables

9. Compressor control switch
10. Earth loom under facia
11. Passenger compartment ventilation fan speed selector

- B. Connector linked to cable system connector described on following page
- a. To injection-ignition electronic control unit
 - b. To connector block connected to ignition switch

The secondary wiring system runs along the upper left side of the engine bay. Its main function is to control the air conditioning system.

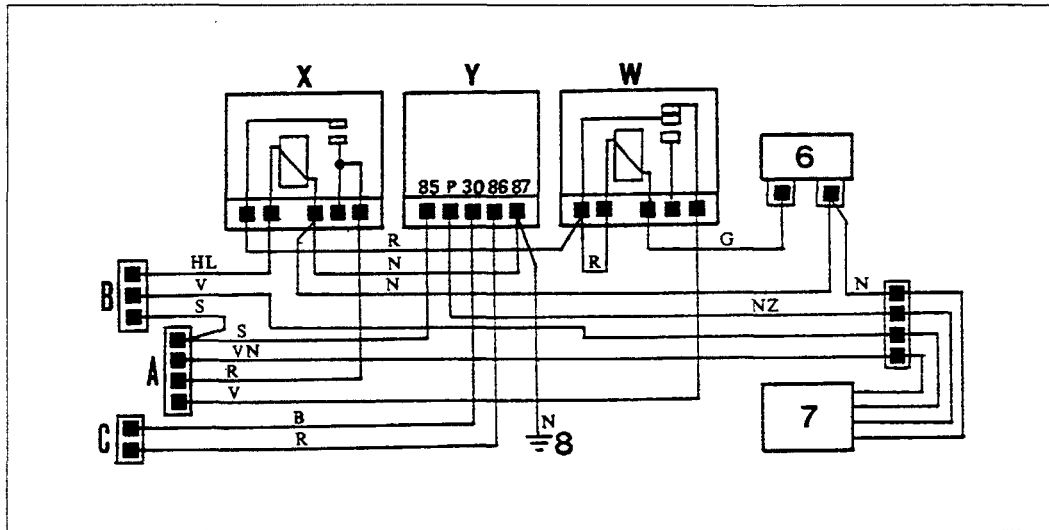

P30007H01

Diagram of secondary wiring system

- 6. Thermal switch screwed onto fitting situated on hose connecting engine to radiator
- 7. Three stage pressure switch
- 8. Connection to left front earth
- A. Connector connected to equivalent on first wiring system
- B. Connector connected to equivalent connector on control circuit described earlier
- C. Connector connected to equivalent connector on basic transverse wiring
- X. Compressor activation switch
- Y. Delay device
- W. Remote control switch for cutting off compressor coupling when engine coolant temperature is too high

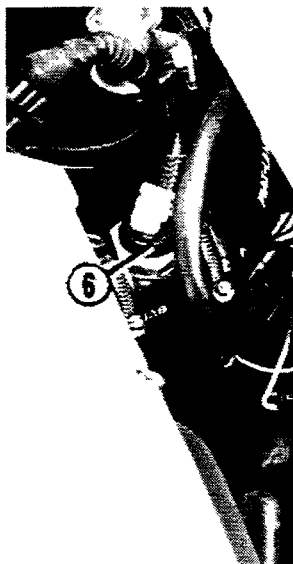

P30007H02

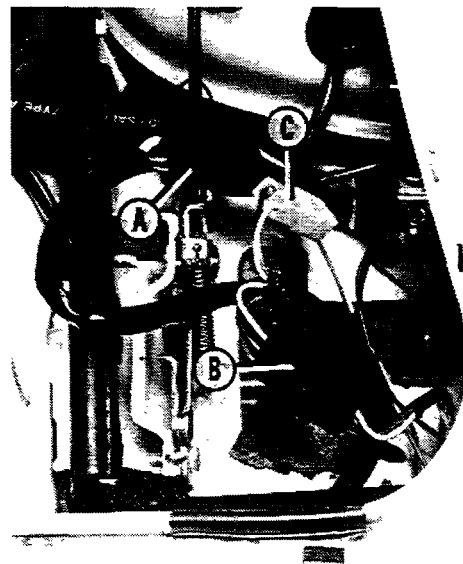

P30007H03

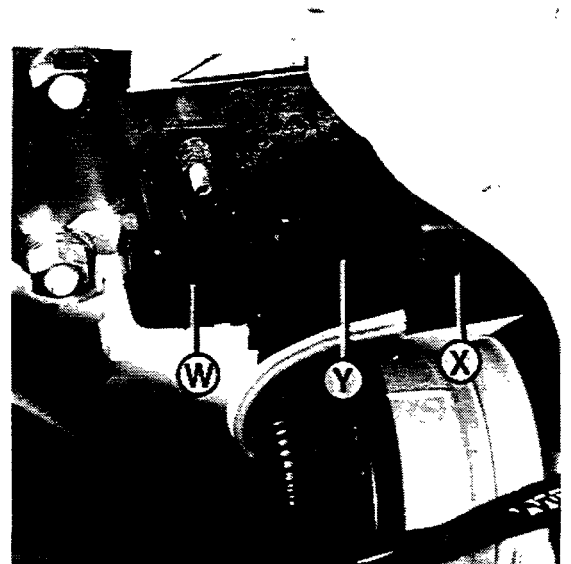

P30007H04

Location of second wiring system parts

The letters and numbers refer to the above mentioned parts

50.

ELECTRICAL FAULTS		
FAULT	POSSIBLE CAUSES	REPAIR
Pulley with electromagnetic coupling not working	Protection fuse or control relay not working Winding of electromagnetic coupling blown Three stage pressure switch not working Thermal switch on compressor not working Thermal switch on radiator-engine hose not working Anti-frost thermostat not working Supply voltage to winding of electromagnetic coupling below normal System pressure below 1.65 bar or drained Compressor activation switch not working	[A] (page 9)
Pulley with electromagnetic coupling slipping	Short circuit in winding of electromagnetic coupling Voltage supplied to winding of electromagnetic coupling below normal	[B] (page 12)
Radiator/condenser cooling fan malfunction	Fuse not working Relay not working Fan motor windings blown or short-circuited Three stage pressure switch not working Two stage thermal switch not working	[C] (page 13)
Passenger compartment ventilation fan malfunction	Fuse, or relay not working Fan motor windings interrupted or short circuited Speed measuring resistor not working Speed selector not working	[D] (page 16)
Engine cannot sustain idle speed	Compressor activation not indicated Injection ECU not working	[E] (page 18)

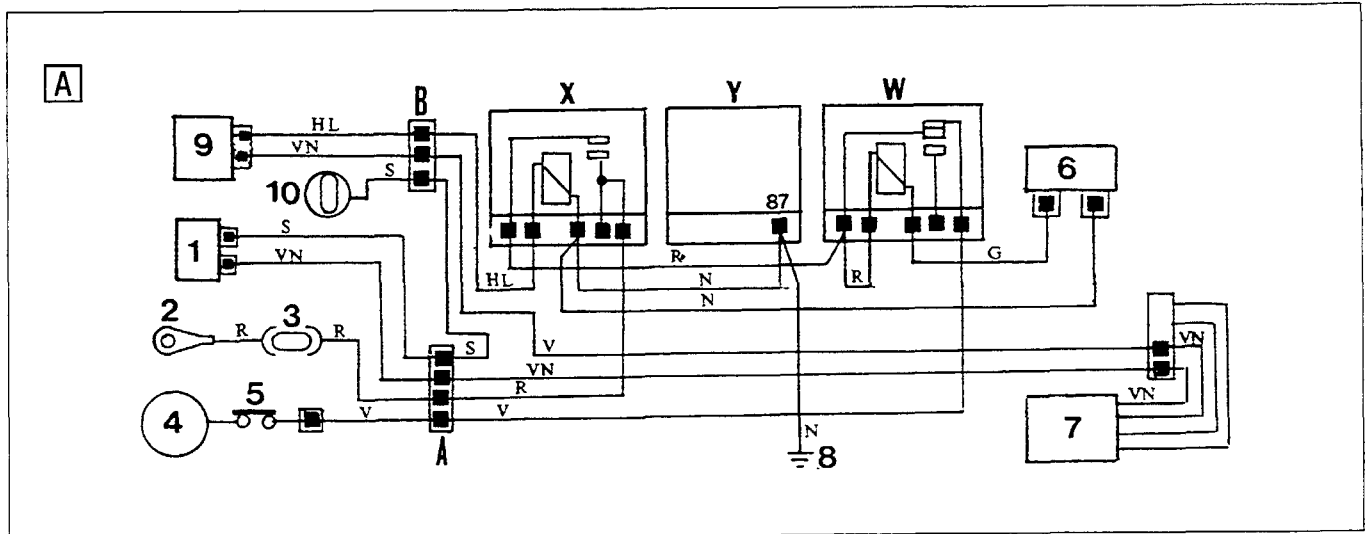

P30009H01

Wiring diagram of compressor pulley electromagnetic coupling

- | | |
|--|--------------------------------------|
| 1. Anti-frost thermostat | 7. Three stage pressure switch |
| 2. Eye terminal linked to connector block pillar | 8. Connection to left front earth |
| 3. 10A removable tag fuse | 9. Air conditioner activation switch |
| 4. Compressor | 10. Ignition switch |
| 5. Thermal switch on compressor | X. Relay |
| 6. Thermal switch on connecting sleeve between engine and radiator | Y. Delay device |
| | W. Remote control switch |
| | A and B. Connections |

Wiring colours	G = Yellow N = Black	R = Red S = Pink	V = Green	HL = Grey/blue VN = Green/black
-----------------------	-------------------------	---------------------	-----------	------------------------------------

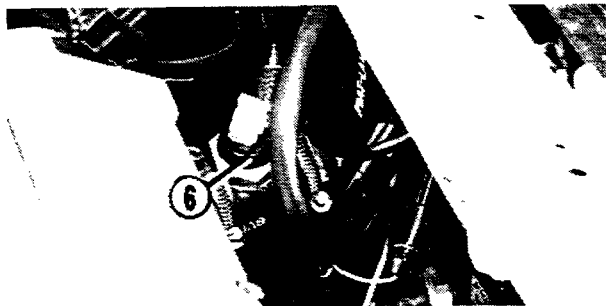
CHECK OPERATIONS	RESULT	REPAIR
Check efficiency of 10 A fuse (number 3 in centre figure on page 6)	Fuse not working	Replace fuse
	Fuse efficient	Carry out operation ②
 <p style="text-align: center; font-size: small;">P30009H02</p>	Electromagnetic coupling not exciting	Carry out operation ③
	Electromagnetic coupling exciting	Replace thermal switch (6)

② Disconnect flag terminals of leads G and N from tag terminals of thermal switch (6) fitted to sleeve linking engine to radiator

50.

CHECK OPERATIONS	RESULT	REPAIRS
<p>③ Remove black remote control switch (W in bottom left figure on page 7) and connect terminals 30 and 87 on switch mount (leads R and V) with jumper. Then turn ignition key to MAR position and switch on air conditioner</p>	Electromagnetic coupling excited	Replace remote control switch (W)
	Electromagnetic coupling not excited	Carry out operation ④
<p>④ Remove green relay (X in bottom right figure on page 7) and connect terminals 30 and 87 (leads R and V) on switch block with a jumper. Then turn ignition key to MAR position and activate air conditioner</p>	Electromagnetic coupling excited	Carry out operation ⑤
	Electromagnetic coupling not excited	Carry out operation ①③
<p>⑤ Connect a multimeter (voltmeter) between terminals 85 and 86 on block of relay X. Then turn ignition key to MAR position and activate air conditioner</p>	12 V tension	Replace relay X
	No voltage	Carry out operation ⑥
<p>⑥ Connect a multimeter (voltmeter) between terminal 85 on block of relay X and earth. Then turn ignition key to MAR and activate air conditioner</p>	12 V tension	Replace broken section of lead N connecting terminal 86 of relay X to left front earth
	Voltage nil	Carry out operation ⑦
<p>⑦ Leave multimeter (voltmeter) connected as in previous test; unplug terminals of leads S and VN from anti-frost pressure switch, connect the two together, and switch on air conditioner</p>	12 V	Replace anti-frost thermostat
	Voltage nil	Carry out operation ⑧
<p>⑧ Connect a multimeter (voltmeter) between earth and terminal of lead S ending at connector A. Then turn ignition key to MAR position</p>	Voltage nil	Replace broken section of lead S connecting ignition switch to connector B and the latter to connector A
	12 V	Carry out operation ⑨

CHECK OPERATIONS	RESULT	REPAIRS
<p>⑨ Connect a multimeter (voltmeter) between terminals 85 and 86 on block of relay X, disconnect both connectors of connection A (see lower centre figure on page 7), and connect terminals of connector A leads S and VN in 2nd wiring system with jumper. Then turn ignition key to MAR and switch on air conditioning.</p>	12 V	Replace broken lead between cables S and VN in primary wiring system connected to anti-frost pressure switch)
	Voltage nil	Carry out operation ⑩
<p>⑩ Disconnect both connection that form connection B, join up terminals of leads V and HL of secondary wiring system connector B with a jumper, and repeat previous check</p>	12 V	Carry out operation ⑪
	Voltage nil	Carry out operation ⑫
<p>⑪ Disconnect end connector of leads HL and VN from air conditioner switch, and connect the two leads with a jumper. Then reconnect both B connectors and repeat previous check.</p>	12 V	Replace air conditioner switch
	Voltage nil	Replace broken section of leads VN or HL connecting above switch to connector B
<p>⑫ Disconnect connector from end cable connector of three-stage pressure switch and connect terminals of cables VN and V with a jumper. Then repeat check ⑩</p>	12 V	Replace three-stage pressure switch after ensuring air conditioning system is drained or nearly drained
	Voltage nil	Replace broken section of cables V and VN connecting three stage pressure switch to connectors A and B of second cable system
<p>⑬ Connect a multimeter (voltmeter) between earth and terminal of lead V of connector connected to connector attached to one terminal of the thermal switch screwed to compressor ends. Then turn on air conditioner.</p>	12V	Carry out operation ⑭
	Voltage nil	Carry out operation ⑮

50.

14 Replace compressor pulley coupling after ensuring above thermal switch is operating correctly

CHECK OPERATIONS	RESULT	REPAIRS
15 Connect a multimeter (voltmeter) between earth and terminal of lead R attached to connector A of primary wiring system	12 V	Replace broken section of lead R connecting connector block to fuse and the latter to connector A of main wiring system
	Voltage nil	Carry out operation 16
16 Reconnect connectors A of main and secondary wiring systems. Then connect a multimeter between earth and terminal 87 of relay X block	12 V	Carry out operation 17
	Voltage nil	Replace lead R connecting connector A of secondary wiring system to terminal 87 of relay X
17 Connect a multimeter (voltmeter) between earth and terminal 87 (lead V) on block of remote control switch W. Then use jumper to connect terminals 87 and 30 of relay X block	12 V	Replace lead V connecting remote control switch to connector A
	Voltage nil	Replace lead R connecting terminal 30 of remote control switch W to terminal 30 of relay X
B Connect a multimeter (voltmeter) between terminal lead of compressor pulley electromagnetic coupling winding and earth.	Voltage below 12 V	Check battery voltage and electromagnetic coupling circuit
	Voltage 12 V	Replace pulley electromagnetic coupling winding

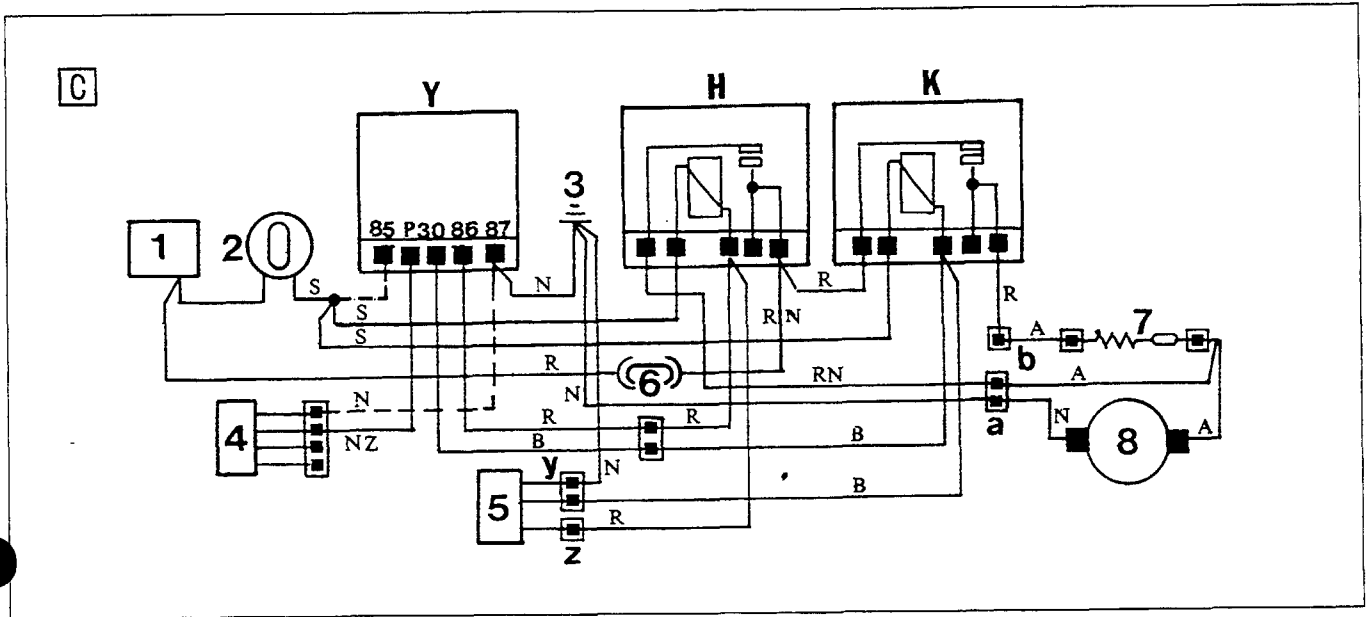

P30013H01

Condenser/radiator cooling fan wiring diagram

- | | |
|---|--|
| 1. Connector block | 8. Radiator/condenser cooling fan |
| 2. Ignition switch | Y. Delay device for activating second speed of fan (8) after interval of about 8 seconds |
| 3. Left front earth | H. Relay for activating second speed of fan (8) |
| 4. Three stage pressure switch | K. Relay for activating first speed of fan (8) |
| 5. Two stage thermal switch | |
| 6. Fuse holder with removable 25A fuse | |
| 7. Resistor with fuse fitted to electric fan duct (8) | |

Connections represented by a broken line are made up of several sections connected to other parts

CHECK OPERATIONS	RESULT	REPAIRS
Check efficiency of 25A fuse (6)	Fuse not working	Replace fuse
	Fuse efficient	Carry out operation 2

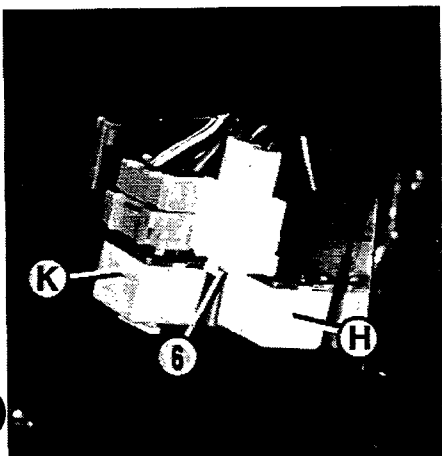

P30013H02

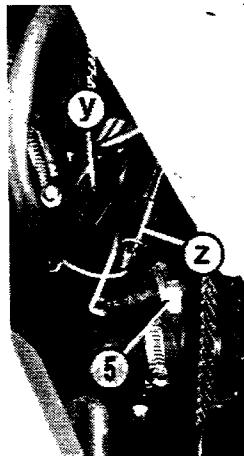

P30013H03

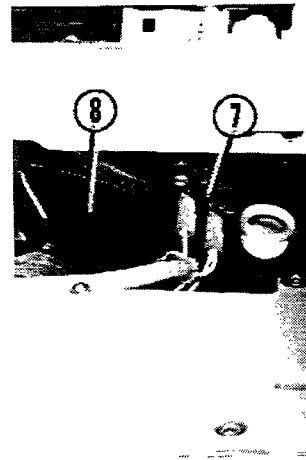

P30013H04

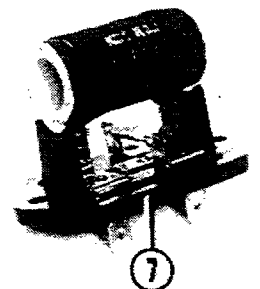

P30013H05

50.

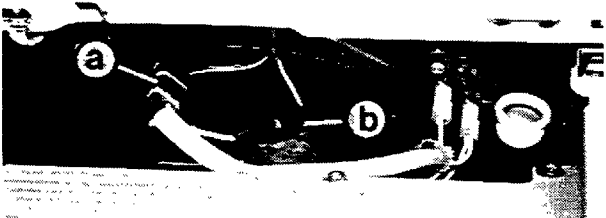
CHECK OPERATIONS	RESULT	REPAIRS
 <p style="text-align: center;">P30014H01</p> <p>② Connect a multimeter (voltmeter) between terminals of leads N and RN of two-way connector marked with letter a . Then remove relay H and connect terminals 30 and 87 of relay block with a jumper.</p>	Voltage 12 V	Replace condenser/radiator cooling fan
<p>③ Connect a multimeter (voltmeter) between terminal of lead N of two-way connector (a in top figure) and end of cable R of one-way connector (b). Then remove relay K and connect terminals 30 and 87 of relay block</p>	Voltage nil	Carry out operation ③
<p>④ Connect a multimeter (ohmmeter) between terminal of lead N of two-way connector (a in top figure) and earth.</p>	Voltage 12 V	Check whether resistor and fuse (7) are in working order. If this is the case, then replace condenser/radiator cooling fan.
<p>⑤ Connect a multimeter (voltmeter) between lead RN connected to terminal 87 of relay H and earth</p>	Voltage nil	Carry out operation ④
	Resistance infinity	Replace lead N connecting electric fan to front left earth
	Resistance nil	Carry out operation ⑤
	12 V	Replace leads RN and R that connect electric fan to terminals 30 and 87 of relays H and K respectively (do not remove lead R if lead R joining the two relays is damaged)
	Voltage nil	Replace lead RN between fuse and terminal 87 of relay H and perform operation ⑥

CHECK OPERATIONS	RESULT	REPAIRS
<p>⑥ Connect a multimeter (voltmeter) between earth and terminals 85 (leads S) on blocks of relays H and K, and turn ignition key to MAR position</p>	12 V	Replace faulty lead S
	Voltage nil	Carry out ⑦ and subsequent operations
<p>⑦ Refit relay K to block (after removing jumper from terminals 30 and 87), disconnect two-way connector (y in second figure at bottom of page 13) from connector attached to terminal leads of thermal switch (5) on radiator, and connect lead B to earth. Then reconnect electric fan supply lead connectors (a and b)</p>	electric fan working	Check continuity and earthing of lead N attached to two-way connector (y). If this is satisfactory, replace thermal switch fitted to radiator.
	fan not working	Replace lead B connecting thermal switch on radiator to relay K
<p>⑧ Refit relay H to block (after removing jumper from terminals 30 and 87), disconnect one-way connector (z in second bottom figure on page 13) from connector attached to one of the terminal leads of thermal switch (5) on radiator. Then connect lead R to earth</p>	electric fan working	Check continuity and earthing of lead N of two-way connector (y). If this is satisfactory, replace thermal switch on radiator.
	fan not working	Replace lead R connecting thermal switch on radiator to relay H
<p>⑨ Disconnect delay device from block and connect terminal 30 (lead B) of block to earth</p>	electric fan working	Carry out operation ⑩
	fan not working	Replace broken section of lead B connecting delay device to relay K
<p>⑩ Connect terminal 86 (lead R) of delay device block to earth</p>	electric fan working	Carry out operation ⑪
	fan not working	Replace broken section of lead R connecting delay device to relay H

50.

CHECK OPERATIONS	RESULT	REPAIRS
<p>①② Connect a multimeter (voltmeter) between terminals 85 and 87 on block of delay device Y, and turn ignition key to MAR position</p>	Voltage 12 V	Carry out operation ①③
	Voltage nil	Replace broken lead between cables N and S attached to terminals of delay device block
<p>①③ Refit delay device to block, disconnect connector attached to three-stage pressure switch terminal leads from connector of secondary wiring system. Then connect terminal of lead NZ of second connector to earth.</p>	Fan comes on at low speed and changes to high speed after about 8 seconds	Check that lead N attached to secondary connector is unbroken. If so, replace three-way pressure switch.
	Electric fan not working	Rermove delay device after ensuring lead NZ connected to terminal P of block to three-way pressure switch is unbroken.

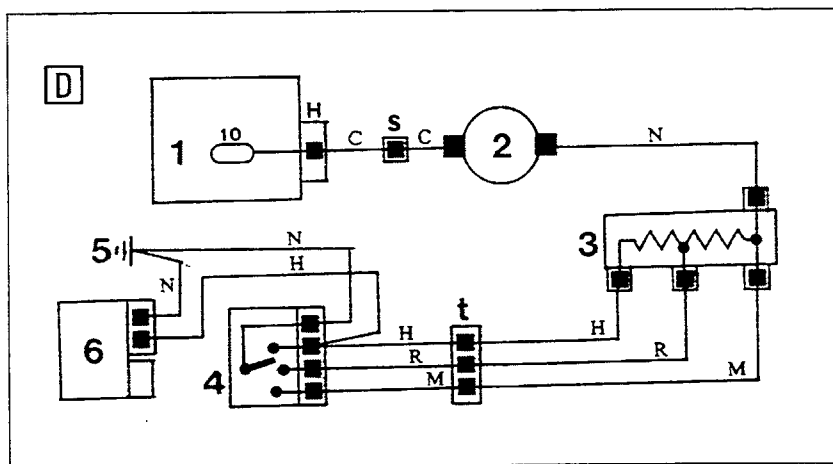

P30016H01

Wiring diagram of passenger compartment ventilation fan

1. Junction unit
 2. Passenger compartment ventilation fan
 3. Resistor
 4. Fan speed switch
 5. Earth loom under instrument panel
 6. Air conditioner compressor switch
- s. One-way connection
t. Three-way connection

CHECK OPERATIONS	RESULT	REPAIRS
<p>Check efficiency of control box fuse 10</p>	Fuse not working	Replace fuse 10
	Fuse working properly	Carry out operation ②

CHECK OPERATIONS	RESULT	REPAIRS
<p>② Connect a multimeter (voltmeter) between terminals of leads supplying fan (connector s of lead C and end of lead N plugged to resistor plate). Then turn ignition key to MAR, and fan speed selector to position 3</p>	Voltage 12 V	Replace fan
	Voltage nil	Carry out operation ③
<p>③ Connect a multimeter (voltmeter) between terminal of lead C (connector s) and earth. Then turn ignition key to MAR</p>	Voltage nil	Replace lead C connecting junction unit to electric fan terminal lead
	Voltage 12 V	Carry out operation ④
<p>④ Disconnect terminals of lead N from tag terminal of resistor plate and connect to earth. Then turn ignition key to MAR.</p>	Fan not working	Replace lead N connecting resistor plate to electric fan
	Fan efficient	Carry out operation ⑤
<p>⑤ Reconnect end of lead N to correct tag terminal on plate and turn fan speed selector knob to position 2 and then to position 1</p>	Fan efficient	Replace broken section of lead M connecting speed switch to resistor
	Fan not working	Carry out operation ⑥
<p>⑥ Remove control assembly and connect a multimeter (ohmmeter) between end of lead N of connector (on fan speed switch) and earth</p>	Resistance nil	Check that resistor is in working order and leads are unbroken. If this is the case, replace fan speed switch.
	Resistance infinity	Replace lead N connecting above switch to earth

50.

If interior fan fails to come on at low speed when air conditioner (compressor) button with snow flake symbol is pressed and fan speed switch is set to "0", carry out the following procedure:

CHECK OPERATIONS	RESULT	REPAIR
<p>① Connect a multimeter (ohmmeter) between terminal of lead N of one of the two connectors fitted to air conditioner switch and earth</p>	Resistance infinity	Replace lead N connecting switch to earth below instrument panel
	Resistance nil	Carry out operation ②
<p>② connect terminals of leads N and H (attached to connector disconnected from compressor switch), with a jumper. Then set fan speed selector to "0"</p>	Fan works at low speed	Replace compressor activation switch
	Fan not working	Replace lead H connecting above switch to fan speed selection switch

Ⓔ When idling, if engine stalls or tends to go off when air conditioning is turned on, check conditions and insulation of HL cable sections that connect connector B of secondary cable system to injection/ignition ECU

Replace ECU if connections are unbroken and no short circuits are found.

Connector B (where lead connected to injection/ignition ECU terminates), is situated on the left hand side of the evaporator/heater unit (see part B in lower centre figure on page 7)

Auxiliary units
Manually controlled heater
50.

Key to components

- 2. Left front earth loom
- 10A. Two stage thermal switch controlling electric fan (11)
- 11. Condenser/radiator cooling fan
- 34. Connector block
- 35. Battery
- 52. Vehicle interior ventilation fan
- 53. Fan speed resistor (52)
- 57. Junction unit
- 62. Electronic injection lead connection
- 65. Earth loom under instrument panel
- 66. Relay for first speed of electric fan (11)
- 84. Fan speed switch (52)
- 100. Ignition switch
- 116. Ignition-injection electronic control unit
- 166. Pulley electromagnetic coupling and compressor thermal switch
- 167. Fuse holder with removable 10A fuse protecting compressor pulley electromagnetic coupling
- 168. Compressor pulley electromagnetic coupling excitation relay
- 171. Air conditioning activating switch
- 175. Anti-frost thermostat
- 233. Relay for second electric fan speed (11)
- 234. Fuse carrier with removable 25 A fuse protecting fan (11)
- 235. Resistor for first fan speed (11)
- 246. Delay device for second fan speed (11)
- 247. Air conditioner deactivation remote control switch
- 248. Air conditioner deactivation thermal switch
- 249. Three stage pressure switch
- 250. Air conditioning system cable connections
- 251. Connection between basic transverse wiring and air conditioning wiring system
- 252. Connection between basic transverse wiring and air conditioning wiring
- 266. Connection between basic transverse wiring system and leads connected to resistor (53)

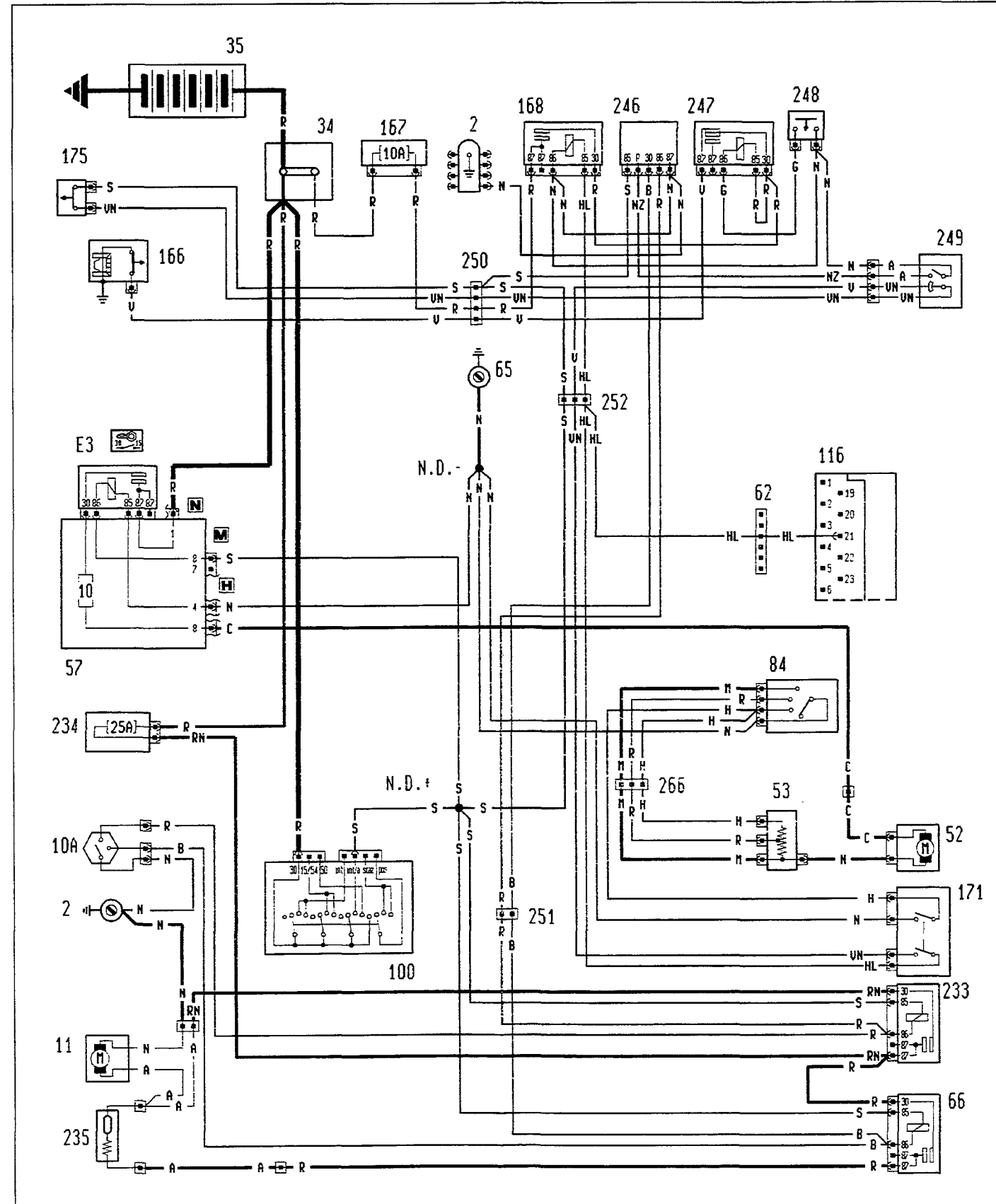

P30019H01